



Window Fittings

This comprehensive range provides the specifier with a wide selection of fittings designed to complement a variety of window styles. The casement, sliding sash and fanlight fittings are traditional in design and based on period originals. Modern production methods are used to ensure the highest standards of quality and performance.

The Liberator Emergency Release Stay has been specifically developed to provide a secondary means of emergency escape where there is also a need to maintain a level of security at all times.

CASEMENT WINDOWS

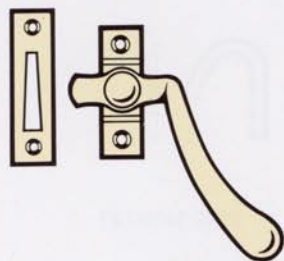

0222M CASEMENT FASTENER C/W MORTICE PLATE

- please specify LH or RH when ordering

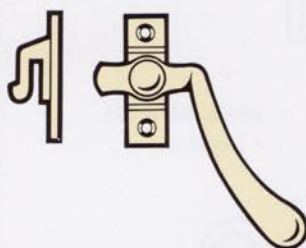

0222H CASEMENT FASTENER C/W HOOK PLATE

- please specify LH or RH when ordering

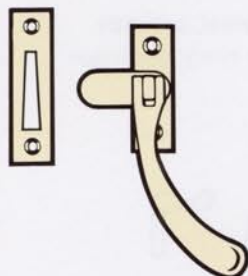

0340M CASEMENT FASTENER C/W MORTICE PLATE

- reversible handle

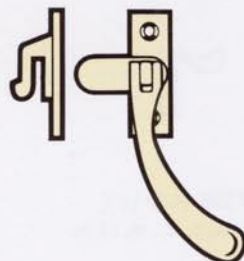

0340H CASEMENT FASTENER C/W HOOK PLATE

- reversible handle

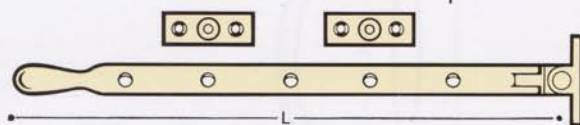

0372 CASEMENT STAY

- supplied c/w 2 pins
- lengths L : 254, 305

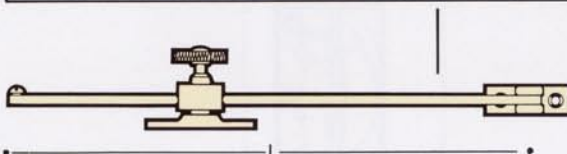

8019K SLIDING STAY

- captive knob turn
- lengths L : 203, 254, 305

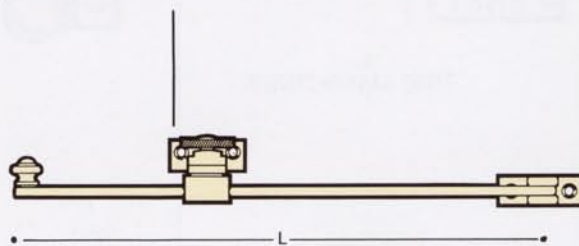

3344 SLIDING STAY

- captive knob turn
- designed for inward opening windows
- lengths L : 254, 305

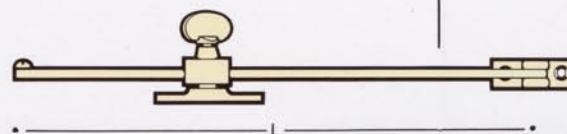

8019T SLIDING STAY

- captive gas tap turn
- lengths L : 203, 254, 305

SASH WINDOWS

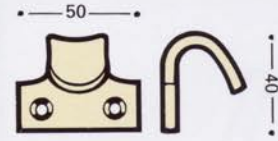

0992 SASH LIFT

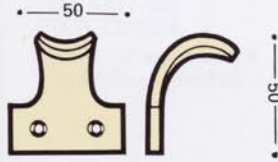

0992C SASH LIFT
• cast design

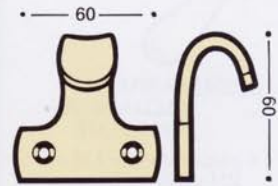

0994C SASH LIFT
• heavy cast design

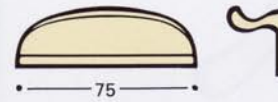

0987 SASH LIFT

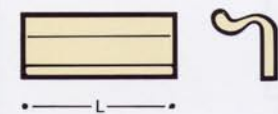

7205 SASH LIFT
Lengths L : 50, 64, 76

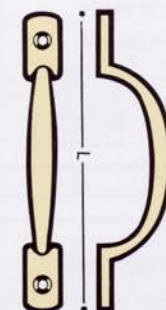

1436 SASH HANDLE
lengths L : 102, 127, 152

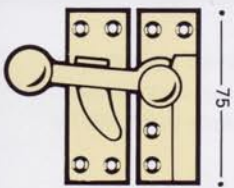

0185 SASH FASTENER



0181 SASH FASTENER
lengths L : 64, 76



1009 SASH EYE

• - 21 - •



0194 FITCH SASH FASTENER

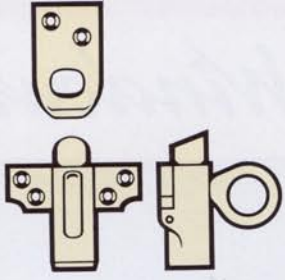

**0737P FANLIGHT CATCH
C/W STRIKE
PLATE**

- solid cast design
- maintenance free oil reservoir

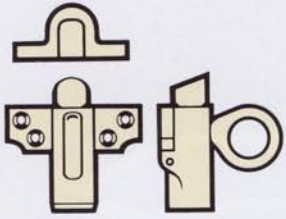

**0737K FANLIGHT CATCH
C/W BOX KEEPER**

- solid cast design
- maintenance free oil reservoir



2155 POLE HOOK

- to suit 25mm diameter pole



2159 POLE HOLDER



4587 ROLLER STAY

- 20mm solid brass roller
- lengths L : 152, 203



4588 ROLLER STAY

- 20mm nylon roller
- lengths L : 152, 203

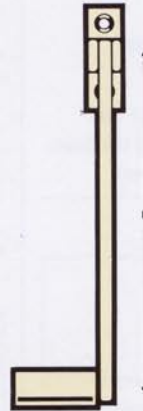

4589 ROLLER STAY

- 38mm solid brass roller
- lengths L : 152, 203



Liberator

Emergency Release Stay for Windows

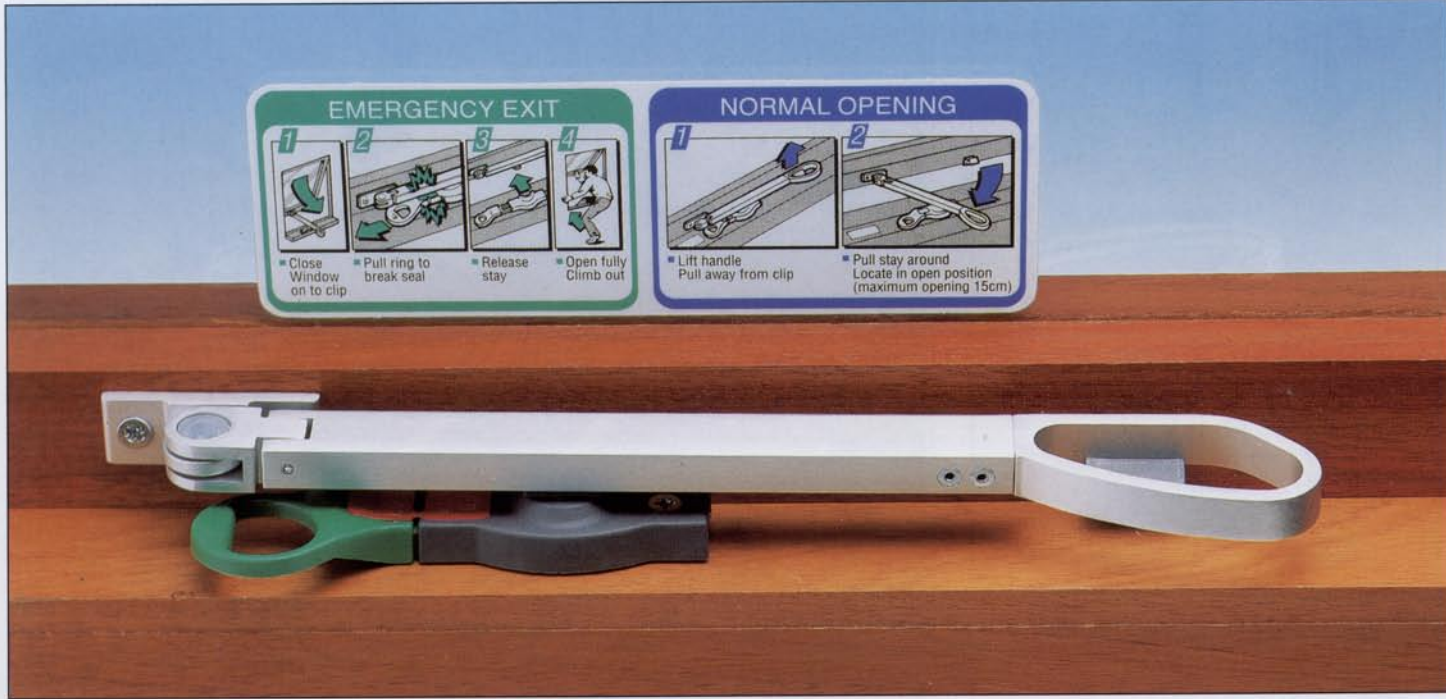

IDEAL FOR USE IN:

- HOTELS
- OFFICES
- HOSPITALS
- SHELTERED HOUSING SCHEMES
- HOLIDAY ACCOMMODATION

Where it is necessary to provide a secondary means of escape from an 'inner room', as described in Building Regulations 1991 (Approved Document B), paragraphs 1.16–1.18, the Liberator should be fitted to a window which

is at least 850mm high

has an unrestricted opening of at least 500mm

has its bottom edge between 900mm and 1100mm above the floor (except roof windows which may be 600mm above the floor)

7075 RELEASE STAY

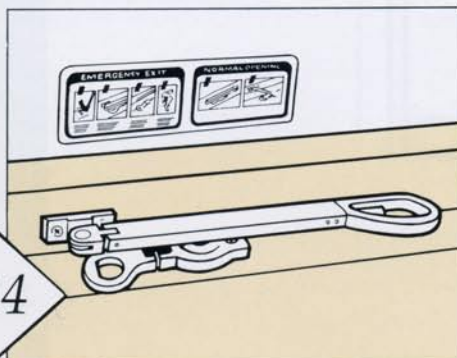

- Simple to understand and easy to operate
- Allows quick and easy exit in an emergency by providing unrestricted opening of normally restricted window
- Provides a deterrent against intruders – without the need for a key
- Allows secure night ventilation

FEATURES INCLUDE

- Captive release ring – for easy resetting
- Tamper-evident strip – to give visual indication of use or abuse
- Adhesive label gives clear instructions for normal and emergency use
- Sleek appearance with a high level of finish – available in satin anodised aluminium as standard
- Available in both left and right hand versions for both side and top hung windows (right hand illustrated)
- Matching non-release version also available – see below
- Supplied with comprehensive fitting instructions with positioning template to ease fitting
- Manufactured in the UK under ISO 9002 Quality Assurance System
- Patent no. 2274876

7077 SUPPORT ARM

- Recommended on top-hung windows, to ensure the window is securely held open to ease escape in an emergency.

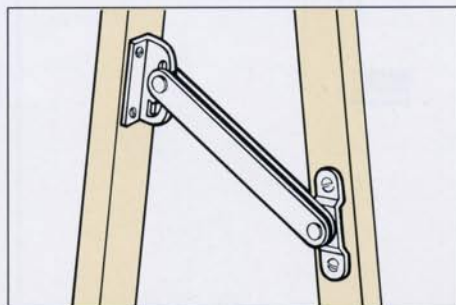

OPERATION

- 1** Restricted opening illustrated – there is an intermediate position for ventilation. The ring cannot be released in this state so the fitting remains secure.

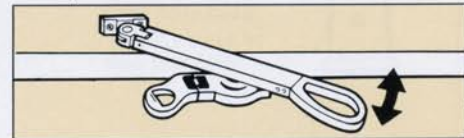

- 2** To operate the emergency function, simply close the window and pull the ring away from its mounting, as shown.



- 3** With the stay released it is possible to push the window open to its full extent. Note: the ring will remain captive within its mounting.

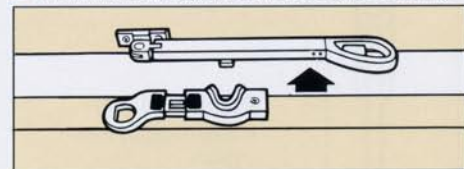

7075X NON-RELEASE STAY

- Security of restricted opening
- Cost saving solution where a room has several windows but only one Release Stay is required.

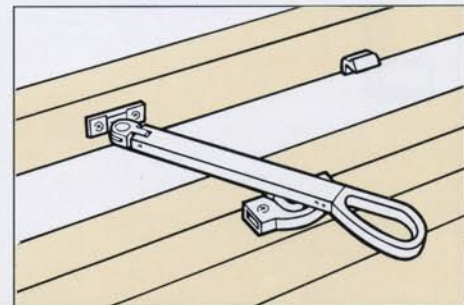



Our Special Product Service offers adaptations to standard products, special surface finishes, and the manufacture of bespoke designs.

Our Design Department, utilizing sophisticated Computer Aided Design equipment, has the capabilities, knowledge and experience to undertake all aspects of product design and development.

Please contact our Sales Department who will be pleased to provide a quotation against your requirements, with drawings and prototypes available upon request.



F R A N K A L L A R T

Frank Allart & Company Ltd

15/35 Great Tindal Street, Ladywood, Birmingham, B16 8DR, UK.

Tel: 0121- 410 6000 Fax: 0121- 410 6066

International · Tel: +44 (0)121- 410 6000 Fax: +44 (0)121- 410 6066

e-mail: sales@allart.co.uk Web Site: www.allart.co.uk

